

ELBOW CxM NO.13 25mm OD x 25mm MI

Product Code : 83019

Brand Name: **elson**

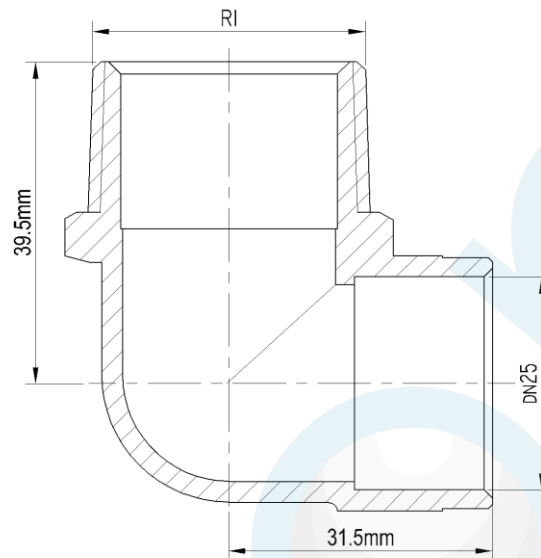

## Product Specification

- Watermark Licence Number: WMKA 02497
- In compliance with AS 3688
- Material: DR Brass, Complies with AS 2345
- Suitable for Potable Water – complies with AS/NZS 4020
- Maximum Working Temperature: 95°C
- Maximum Working Pressure at 20°C : 2100Kpa
- Threads are all BSP

Elson Australasia Pty Ltd

Tel: 02 9625 7899 Fax: 02 9625 7855

Website: [www.elson.net.au](http://www.elson.net.au) E-mail: [sales@elson.net.au](mailto:sales@elson.net.au)

Version 2.0

Aug. 2020